

**BEPR- 822U**  
**Digital Asynchronous Motor**  
**Protection Device**  
**Technical Manual**

# CONTENTS

Part 1 .....	0
1 Brief Introduction.....	1
2 Technical Parameters .....	2
2.1 Rated parameters.....	3
2.1.1 Rated DC voltage: 220V or 110V (please specify in the order).....	3
2.1.2 Rated AC data: .....	3
2.1.3 Power consumption:.....	3
2.1.4 Status vector level .....	3
2.2 Main technical performance.....	3
2.2.1 Sampling circuit precise working range (5% error).....	3
2.2.2 Contact capacity .....	3
2.2.3 Tripping and closing current .....	3
2.2.4 Setting error of each type of component .....	3
2.2.5 Group operation time (including relay inherent time).....	4
2.3 Insulation capability .....	4
2.3.1 Insulation resistance .....	4
2.3.2 Medium intensity .....	4
2.3.3 Impulse voltage .....	4
2.3.4 Humidity and heat resistant performance.....	4
2.4 Anti-electromagnetic interference capability .....	4
2.4.1 Pulse interference.....	4
2.4.2 Fast Transient interference.....	5
2.4.3 Static discharge .....	5
2.4.4 Radiated electromagnetic Field interference.....	5
2.4.5 Surge .....	5
2.5 Mechanical performance.....	5
2.5.1 Vibration .....	5
2.5.2 Impulse.....	5
2.5.3 Collision.....	5
2.6 Environmental conditions .....	5
3 Hardware.....	6
3.1 Cubicle structure .....	6
3.2 AC module .....	6
3.3 CPU module.....	7
3.4 Power supply module.....	8
3.5 Man-machine interaction module .....	8
4 Main Functions .....	9
4.1 Startup time .....	9
4.2 Overheat protection.....	10
4.3 Instantaneous protection .....	12



---

4.4 Over-current protection .....	12
4.5 Zero-sequence current protection .....	12
4.6 Negative-sequence current element .....	13
4.7 Inverse-time limit element .....	14
4.8 Overload protection .....	14
4.9 Long-time startup protection .....	14
4.10 Rotor-locked protection .....	15
4.11 Fuse protection .....	15
4.12 F-C blocking function .....	15
4.13 Under voltage protection .....	15
4.14 Over-voltage protection .....	16
4.15 Zero-sequence voltage protection .....	16
4.16 Non-electric quantity protection .....	16
4.17 TV wire break detection .....	17
4.18 Measurement function .....	17
5 Settings and Setting Specifications .....	18
5.1 Setting value list and specifications of BEPR- 822U Digital Asynchronous Motor Protection	18
5.2 Soft pressure plates and specification of BEPR- 822U Series Digital Asynchronous Motor Protection .....	22
Part 2 .....	23
1 Introduction .....	24
1.1 Keyboard .....	24
2 Menu operation .....	25
2.1 Functions .....	25
2.1.1 Sampling .....	25
2.1.2 Event .....	25
2.1.3 Rated value .....	25
2.1.4 System setup .....	25
2.1.5 System test .....	26
2.1.6 Others .....	26
2.1.7 Operation set up .....	26
2.2 Operation instructions .....	26
2.2.1 Normal display .....	26
2.2.2 Primary menu .....	27
2.2.3 Sampling .....	27
2.2.3.1 RMS .....	27
2.2.3.2 Measured value .....	27
2.2.3.3 Electric quantity .....	27
2.2.4 Event .....	28
2.2.4.1 Report display .....	28
2.2.4.2 Recording printing .....	29
2.2.5 Setting .....	29

2.2.5.1 Setting display.....	29
------------------------------	----



---

2.2.5.2 Setting alteration .....	29
2.2.5.3 Setting switchover .....	31
2.2.5.4 Setting printing .....	31
2.2.6 System setup .....	31
2.2.6.1 Pressure plate setup .....	31
2.2.6.2 Time adjustment .....	32
2.2.6.3 Energy-measuring setup .....	32
2.2.6.3.1 Offset shift check .....	32
2.2.6.3.2 Gain check setup .....	33
2.2.6.3.3 Energy-measuring setup .....	33
2.2.6.3.4 Energy zero clearance .....	33
2.2.7 System test .....	33
2.2.7.1 Switch-out drive .....	34
2.2.7.2 Switch-in check .....	34
2.2.7.3 AC test .....	34
2.2.7.4 Integrated automation function .....	35
2.2.7.4.1 Protection upstream transmission .....	35
2.2.7.4.2 Alarm upstream transmission .....	36
2.2.7.4.3 Telesignalling upstream transmission .....	36
2.2.7.4.4 Telemetry upstream transmission .....	37
2.2.7.4.5 Code list printing .....	38
2.2.8 Others .....	38
2.2.8.1 Version information .....	38
2.2.8.2 Logic information .....	38
2.2.8.3 Identification .....	38
2.2.9 Operation setup .....	39
2.2.9.1 Pressure plate setup .....	39
2.2.9.2 Setting switchover .....	40
2.2.9.3 Setting alteration .....	40
2.2.9.4 Time adjustment .....	41
2.2.10 Note .....	42
3 Debugging Outlines for Users .....	42
3.1 Check before energization .....	42
3.2 Insulation check .....	42
3.3 Energization check .....	43
3.4 Sampling precision check .....	43
3.5 Contact output check .....	43
3.6 Setting check .....	43
3.7 Tripping and closing current hold test .....	43
3.8 Phase sequence check .....	43
3.9 Calibration of the clock .....	44

Part 1  
**Technical Manual**

### 1 Brief Introduction

BEPR- 822U Digital Asynchronous Motor Protection is applicable for 3kV, 6kV, 10kV non-direct-grounding system serve, as protection for the internal faults, overloadings, etc. of the large and middle asynchronous motors.

The basic configuration of this protection would be two CPU modules, protection and control unit composed of 32-bit microprocessor, which is configured with the bulk RAM and Flash Memory, with strong ability of data processing, logic computation and information storage. Another CPU is the man-machine interface unit composed of single chip computer, whose bus is not out of the chip. The two CUP modules are mutually independent, with no interrelation. Each protection function and automation function would be realized by software.

#### 1) Features:

- All English character LCD display, and clear and easy man-machine interface.
- The precision of the selected measuring modules (including KWH metering ) can reach to the class 0.5.
- To provide access to the accumulated pulse-degree side.
- High speed Ethernet interface is provided to integrated the IEC 870-5-103 standard communication protocol.
- High precision clock chips are used. The GPS time checking circuit is provided to realize the clock synchronism of the whole system.
- High speed Ethernet interface is provided to integrated the IEC 870-5-103 standard communication protocol.
- The core of CPU, the protection functional module is the powerful 32-bit micro- processors with large capacity RAM and Flash Memory. They are powerful to process data, perform logic calculation and store information. 8 to 50 recorded reports and 1000 events can be recorded. These information will not be lost even in power interruption.

#### 2) Complete protection function configuration

Table 1 Type and function configuration list of these series products

Function	BEPR- 822U
Current instantaneous protection	√
Over-current protection (definite-time limit or inverse-time limit)	√
Negative sequence over-current (definite-time limit or inverse-time limit)	√
Overheat protection	√
Overload protection	√



Function		BEPR- 822U
Long-time startup protection		√
Rotor-locked protection		√
Fuse protection		√
F-C locking function		√
Zero-sequence current protection (trip or alarm)		√
Under-voltage protection		√
Over-voltage protection		√
Zero-sequence over-voltage protection		√
Non-electric quantity protection		√
Two phase differential instantaneous protection		
Two phase current longitudinal differential protection		
Telemeter	Measurement TA	alternative use
	Protection TA	alternative use
Telesignal		alternative use
Telecontrol		alternative use
KWh	Pulse metering	√
GPS Time synchronization		√
False-blocking prevention		√
Remote management		√

**3) Monitoring**

- Telemeter: Ia, Ib, Ic, Ua, Ub, Uc, P, Q, f and other analog telemetry
- Telecontrol: Division and the normal remote control circuit breaker
- Telesignal: 16way telesignalling open into the volume of the collection, installation of remote signal deformation, events, letters and other remote
- Remote pulse: 2-way electric-degree pulse input
- Out: Device has a 11 way out, of which 8road trip because of the export-driven relay, 3-way signal drive for the notice of police.
- GPS time-checking

**2 Technical Parameters**





<https://www.bueno-electric.com>

## 2.1 Rated parameters

2.1.1 Rated DC voltage: 220V or 110V (please specify in the order)

2.1.2 Rated AC data:

- a) AC voltage 100 / 3 V
- b) AC current 5A or 1A (please specify in the order)
- c) Rated frequency 50Hz

2.1.3 Power consumption:

- a) DC circuit Under normal work, no more than 8W  
During operation, no more than 12W
- b) AC voltage circuit No more than 0.5VA for each phase
- c) AC current circuit When the rated current is 5A: no more than 1.0VA for each phase.

When the rated current is 1A: no more than 0.5VA for each phase.

2.1.4 Status vector level

The input status vector level of CPU and communication interface module 24V (18 V~30V) CPU output status vector (photo-coupling output) Permitted level 24V (18 V~30V) Driving capability 150mA

## 2.2 Main technical performance

2.2.1 Sampling circuit precise working range (5% error)

- Voltage: 0.4 V~120.0V
- Current: 0.20A~100.0A (When rated current is 5A.)
- Zero-sequence current: 0.02A~5.50A or 0.1A~20.0A

2.2.2 Contact capacity

- Operation circuit contact load: closing capacity 220VDC 5A;
- Signal circuit contact load: switching capacity 220VDC 0.15A

2.2.3 Tripping and closing current

- CB tripping current 0.5A~5A and above (please specify in the order)
- CB closing current 0.5A~5A and above (please specify in the order)

2.2.4 Setting error of each type of component

- Current component:  $\leq \pm 5\%$
- Voltage component:  $\leq \pm 3\%$
- Time component:  $\leq (2\% \text{ setting value}) + 50\text{ms}$



<https://www.bueno-electric.com>

### 2.2.5 Group operation time (including relay inherent time)

Inherent time of fast operation zone: when it is measured at 1.2 times of setting,, no more than 40ms

Inherent time of differential operation: when it is measured at 1.5 times of setting, no more than 30ms

## 2.3 Insulation capability

### 2.3.1 Insulation resistance

The charged parts and uncharged parts casings, as well as irrelevant electrical circuits are easured by Meg-ohmmeter with open-circuit voltage of 500V, to determine the value of nsulation resistance. Under normal experiment atmospheric condition, each circuit insulation resistance of all levels could not be less than 20MΩ.

### 2.3.2 Medium intensity

Under normal experiment atmospheric condition, this device can endure frequency of 50Hz, signal input terminal voltage to ground is 500V, and other circuit voltage to ground is 2000V. uring one-minute power frequency voltage withstand test, there is not puncture, flashover and component damage event. During the test, when any testing circuit is energized, all the other circuits are potential interconnected and grounded equipotentially.

### 2.3.3 Impulse voltage

Under normal experiment atmospheric condition, the power input circuit, AC input circuit, output contact circuit to ground, and all the circuits are able to endure short-time standard lightning impulse voltage test of 1.2/50μs, with open-circuit test voltage of 5kV.

### 2.3.4 Humidity and heat resistant performance

This device can endure the constant humidity and heat test stipulated in the GB/T 2423.9, with test temperature +40°C±2°C, relative humidity (93±3)%, and test time of 48h. Within two hours after the completion of test, according to the requirements in 2.3.1, among the outside uncharged parts of each conductive circuit, the casing and irrelevant electrical circuits, the insulation resistance is measured, to be not less than 1.5MΩ. The medium voltage withstand intensity is not below the 75% of voltage amplitude in medium intensity test, as stipulated in 2.3.2.

## 2.4 Anti-electromagnetic interference capability

### 2.4.1 Pulse interference

This device can endure the interference test stipulated in GB/T 14598.13-1998, and the test power frequency is 100kHz and 1MHz, and test voltage is common-mode 2500V, with decaying oscillatory wave of differential



<https://www.bueno-electric.com>

mode 1000V. During the test, power is applied to test device in advance; according to critical condition superposed interference test voltage listed in Table 3.1.1 in GB/T 14598.13, there is no maloperation and operation rejection.

#### 2.4.2 Fast Transient interference

This device can endure the (4kV±10%) fast transient interference test of class IV stipulated in GB/T 14598.10-1996 standard.

#### 2.4.3 Static discharge

This device can endure the (space discharge 15kV, contact discharge 8kV) static discharge test of class IV stipulated in GB/T 14598.14-1998 standard.

#### 2.4.4 Radiated electromagnetic Field interference

This device can endure the radiated electromagnetic field interference test severity of class III stipulated in GB/T 14598.9-2002 standard.

#### 2.4.5 Surge

This device can endure the interference test (common mode 2000V, differential mode 1000V), the surge (impact) interference resistance capability test of class III stipulated in GB/T 17626.5—1999 standard.

### 2.5 Mechanical performance

#### 2.5.1 Vibration

This device can endure the vibration response test of severity class I stipulated in 3.2.1 of GB/T 11287-2000. This device can endure the first level grimness vibration duration test regulated in 3.2.2 of GB/T 11287-2000.

#### 2.5.2 Impulse

This device can endure the impulse response test of severity class I stipulated in 4.2.1 of GB/T 14537-1993. This device can endure the first level grimness impact duration test regulated in 4.2.2 of GB/T 14537-1993.

#### 2.5.3 Collision

This device can endure the impulse and collision test of severity class I stipulated in 4.3 of GB/T 14537-1993.

### 2.6 Environmental conditions

#### a) Environmental temperature:

Work: -10°C~+55°C; -25°C~+70°C (according to contract requirements)

Storage: -25°C~+70°C, if, under limit value, no energized quantities are applied, and the device would not be irreversibly changed. The device can normally operate when the temperature recovers.

Contact: [sales@bueno-electric.com](mailto:sales@bueno-electric.com)

Fax: +86-25-51816989



<https://www.bueno-electric.com>

b) Relative humidity: 5%~95% ((There is no dew or ice inside the product.)

c) Atmospheric pressure: 86kPa~106kPa

### **3 Hardware**

The demand of reliability is fully considered for overall design and design of each module. In the fields of program execution, signal indication, and communication, elaborate consideration have been given out. Therefore, when the panel-assembly operations for this device are made or when the device is mounted on the switch cabinet, additional AC, DC input anti-interference modules do not need to be installed.

#### **3.1 Cubicle structure**

This device adopts the integral form, including English LCD, signal indicating light, operating keyboard, etc.

This cubicle adopts entirely enclosed design of waterproof, dustproof and anti-vibration, to ensure its high reliability when installing in severe field environment.

#### **3.2 AC module**

The AC module includes two parts of voltage input and current input, and there are different numbers for voltage and current input components of different types.

Voltage input component is constituted by voltage converter. When its input is AC 100V, the output is AC 3V. The output linear range is form 0.4V to 120V.

Current input component is composed of current converter and shunt resistors.

There are three specifications.

- 1) TA used when rated current is 5A: when input is 100A, output is  $5/\sqrt{2}$  V, and the input linear range is form 0.2A to 100A.
- 2) TA used when rated current is 1A: when input is 20A, output is  $5/\sqrt{2}$  V, and the input linear range is form 100mA to 20A.
- 3) TA used for measurement and zero-sequence: when input is 5.5A, output is  $5/\sqrt{2}$  V, and the input linear range is from 20mA to 6A.

3.3 CPU module

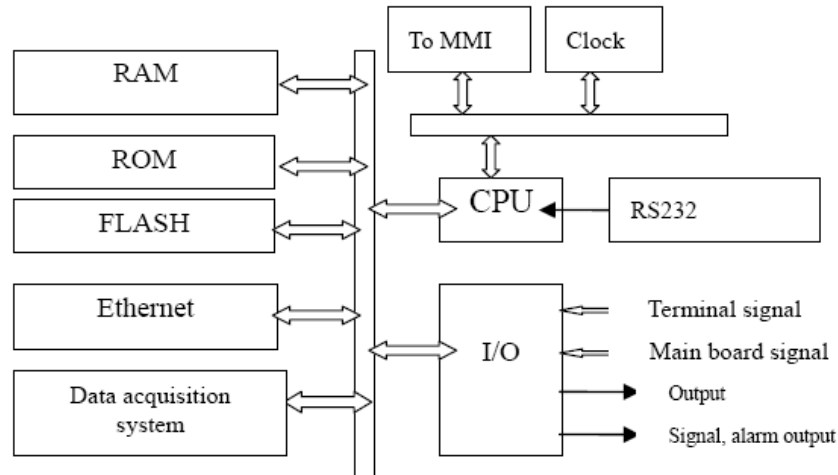

Schematic diagram of CPU module

The CPU module is composed of the following parts:

**1) CPU System**

CPU system is structured by microprocessor CPU, RAM, ROM, Flash Memory, etc. The microprocessor CPU (32-bit) with high capability, large capacity ROM (1M bytes) , RAM (1M bytes) and Flash Memory (1M bytes) make this CPU module possess the strong data processing and recording capability, which could realize various complicated fault processing scenarios and could record large amount of fault data. The protection program compiled in C language would make the program have strong reliability, excellent transplantability and maintainability.

**2) Data acquisition system**

The data acquisition system of protection system is composed of 14-bit precision A/D converter with high reliability, multiplexers switch and filter circuit. Inside A/D conversion chip with the latest technology, there are sampling hold and synchronous circuit, which has the advantages of rapid conversion speed, low sampling error, very little power consumption and excellent stability. Therefore, there is no adjustable component for sampling circuit, and there is no need to adjust in the field, and the device has excellent reliability.

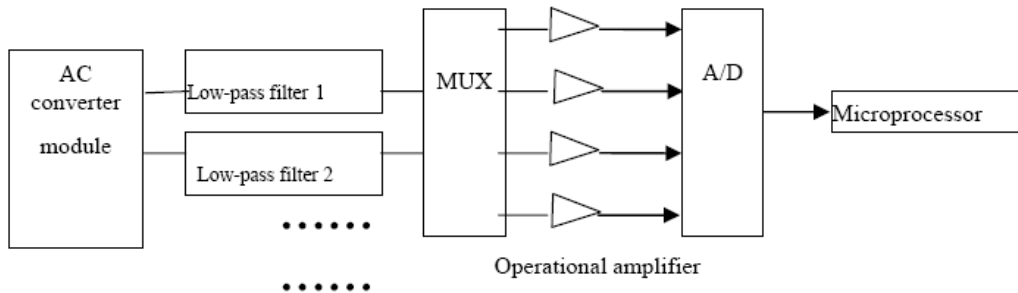

**3) Communication part**

Contact: [sales@bueno-electric.com](mailto:sales@bueno-electric.com)

Fax: +86-25-51816989

A SCI (standard RS232 serial interface) is configured for this device, used for connection with PC. Various tests would be carried out with the help of strong function of PC and the configured special commissioning software package.

Inside this module, there could be Ethernet chip (selected) with very high communication speed and with universal interface, used as communication interface for this device to connect with system. Common mode: the device provides RJ45 communication interface, using shielded twisted pairs 5 (STP5) as communication media.

#### 4) Clock circuit

Hardware clock circuit is configured inside the module. Besides, CPU module adopts multi-layer PCBs and SMT technique, with small and deft appearance and compact structure, which greatly improve the reliability and EMI resistant ability.

#### 3.4 Power supply module

This module is DC inverted power supply module. Through anti-interference filter circuit, DC 220V or 110V voltage would output necessary four groups of DC voltage, 5V, 12V, 24V(1) and 24V(2), utilizing inversion principle. The four groups of voltage are not common-grounded, and apply floating mode, and they are unconnected with the rack.

- a) 5V,12V are the power supply for CPU
- b) 24V(1) is the power supply for driving relays
- c) 24V(2) is the power supply for exterior inputs

To strengthen anti-interference ability of power supply module, the 24V power supply of DC inputs and leading-out terminals are fitted with filters. The power supply module electric principle schematic is shown in Figure 3-3.

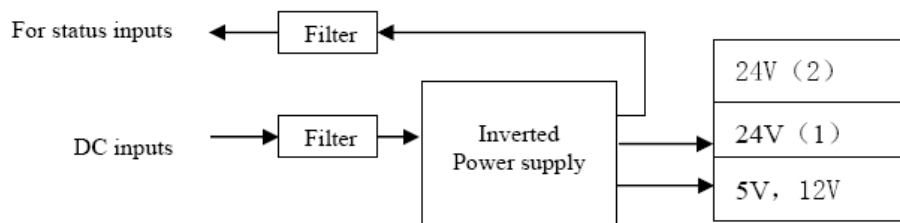

Figure 3-3 Schematic diagram of the power supply module

#### 3.5 Man-machine interaction module

The core of man-machine interaction (MMI) module is the single chip computer, whose bus is not in the outside of the chip. Its main function is to display protection CPU output information, scan the keyboard status on panel, and real-time transmit it to protection CPU. Therefore, for protection CPU, man-machine interaction module is equivalent to its peripheral equipment. The communication between CPU and MMI is carried out through SPI interface, with speed as high as 2Mb/s, which has high reliability. Using this configuration mode, the Contact: [sales@bueno-electric.com](mailto:sales@bueno-electric.com) Fax: +86-25-51816989



large amount of bus import can be avoided, and protection reliability is improved. Moreover, almost, it would not increase the product cost, and would enhance cost-effectiveness.

The display window of this module adopts four lines, with LCD of 12 English characters in each line. The man-machine interface is clear and easy to understand, configured with universal keyboard operation mode of PS series protection, making the man-machine interaction more convenient and simple. Meanwhile, considering the characteristics of low voltage protection operation, plenty light indication information is configured in this module, making operation information more visual.

## 4 Main Functions

Due to the great improvement of computation capability after using 32-bit microprocessor, all the components can be computed in real-time, which would greatly improve the overall reliability of protection.

### 4.1 Startup time

Mode of measuring motor startup time: the timing would begin when motor maximum phase current changes suddenly from zero to  $10\%I_e$ , until startup current passing peak value and descending to  $120\%I_e$  ( $I_e$  is motor rated current, same below) .

The time period between the two points is called motor startup time. Meanwhile, motor startup time setting  $T_{start0}$  should be entered in settings, and it represents the time that is taken form the motor startup to its rotation speed reaching rated rotation speed, which could be set to be 1.2 times of motor longest startup time.

For measured motor startup time  $T_{start}$  and startup setting  $T_{start0}$ , the device would treat the shorter one as real motor startup process time. Therefore, for each motor startup, the device would experience different startup process time.

For BEPR- 822U Digital Asynchronous Motor Protections, the last soft jumper light on device panel is defined as motor startup time indicating light, which would be lit during motor startup period, and visually show the startup process.

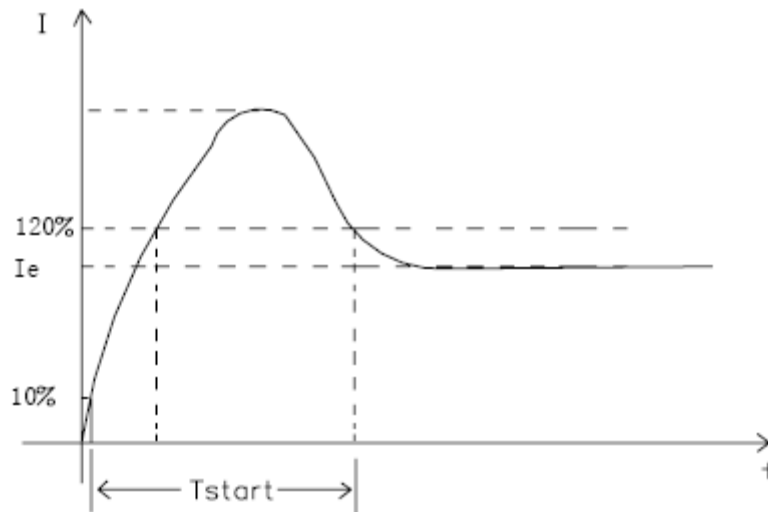

Asynchronous motor startup current characteristic

#### 4.2 Overheat protection

The heat effects of motor positive-sequence, negative-sequence current are considered comprehensively, to provide overheat protection for the overheats caused by various overloads, and as the standby protection for motor short circuits, overtime startup, rotor-locked, etc.

Equivalent current  $I_{eq}$  is used to simulate motor heating effect, that is:

$$I_{eq} = \sqrt{K_1 I_1^2 + K_2 I_2^2}$$

$I_{eq}$  is equivalent current

$I_1$  is positive-sequence current

$I_2$  is negative-sequence current

$K_1$  is heat coefficient of positive-sequence current, and during motor startup,  $K_1 = 0.5$ ; after startup completion, it is recovered to be  $K_1 = 1$ ;

$K_2$  is heat coefficient of negative-sequence current,  $K_2 = 3 \sim 10$ ,  $K_2 = 6$  could be taken.

According to motor heat model, the characteristic curve between motor operation time  $t$  and equivalent operation current  $I_{eq}$  is given in the following formula.

$$t = \tau \times \ln \frac{I_{eq}^2 - I_p^2}{I_{eq}^2 - I_\infty^2}$$

$I_p$ : Load current before overload, if it is at cold state before overload,  $I_p$

$I_\infty$ : Long-term permitted load current, to protect current limit regulated in requirements of non-operation, which is “overheat protection startup current”. It could be set based on 1.05~1.15 times of rated current  $I_e$ .





<https://www.bueno-electric.com>

$\tau$ : Heat time constant, reflecting motor overload capability

This criterion fully considers the thermal process and thermal status before overload of motor stator. The device would use thermal capacity to represent motor thermal process, and thermal capacity is proportional to the square of stator current.

Through conversion, its dimension is turned to be time constant  $\tau$ , reflecting motor overload capability. When the value of thermal capacity reaches  $\tau$ , the device would trip. When thermal capacity reaches  $K_a \times \tau$ , overheat alarm is sent. Thereinto,  $K_a$  is alarm coefficient, with value range:

$$\left(\frac{I_{eq}}{I_{\infty}}\right)^2 < K_a < 1$$

Overheat alarm could be set as (60~99.9)% of overheat trip thermal capacity value. The device would provide real-time thermal capacity percentage display, alarm light indicator and signal contact output. The overheat alarm function could be controlled through control character KG1.0. When overheat alarm function operates, no matter whether overheat protection soft jumper is operating, the alarm would function.

During motor operation, heat dissipation time constant is the same as heat time constant  $\tau$ . After motor shutdown, the dissipation effect is getting worse. The lower cooling capability of motor makes dissipation time constant longer than heat time constant  $\tau$ , dissipation time constant would automatically increase to be certain times of heat time constant  $\tau$ , in order to correctly reflect heat effect. The times of dissipation time could be selected from 1 to 5, and the default tacitly approved value is 4 times, according to real environment condition.

According to the principle that motor could start for continuous two times, and the percentage of each startup thermal capacity should not be larger than 50% of trip value, so when thermal capacity percentage descends to below 50%, device closing blocking contact returns. After overheat protection trip, the function of overheat holding starts, and output contact would always be closed, until thermal capacity percentage descending to below 50%, the overheat closing blocking contact would return, and the motor could restart at this time. In case of emergency, when immediate startup is required, press “<” key and “>” key on device panel at the same time, and carry out overheat reset operation according to cues. This overheat blocking function could be controlled through control character KG1.1, and its output is the standby output 4(6X:15~6X:16).

Heat time constant  $\tau$  should be provided by motor manufactory, if the manufactory dose not offer this, it could be estimated using one of the following methods:

- ① If the manufactory provides motor thermal limit curve or a group of overload capability data,  $\tau$  could be computed according to following formula:



$$\tau = \frac{t}{\ln \frac{I^2}{I^2 - I_{\infty}^2}}$$

When a group of  $\tau$  value is get, take the relevant smaller value.

⊙ If the rotor-locked current  $I$  and permitted rotor-locked time  $t$  are already known,  $\tau$  could be estimated

$$\tau = \frac{t}{\ln \frac{I^2}{I^2 - I_{\infty}^2}}$$

according to following formula:

#### 4.3 Instantaneous protection

The instantaneous protection could be realized through judging the amount of current, with setting range of  $(4 \sim 12)I_e$ . The instantaneous protection current setting would automatically be halved after motor startup. In this way, on one hand, the huge startup current of motor could be effectively avoided, and on the other hand, rotor-locked protection caused by serious overload would be ensured after normal motor startup.

The operation time could be set. For motors controlled by breaker, the setting time is relevantly short. For motors controlled by contactor, the setting time is relevantly long. The selectable setting time is 0.3 seconds.

#### 4.4 Over-current protection

Over-current protection would automatically exit when motor starts, and would automatically operate when the startup finishes. When the current is larger than setting current and reaches setting time, over current protection would output. The over current protection function would be controlled through control character KG1.2, to select definite-time limit or inverse-time limit mode.

#### 4.5 Zero-sequence current protection

The motor grounding current is dependent on power supply system grounding mode. In ungrounded or high-resistance-grounded system, fault current is only a few Ampere. In the medium-resistance ground system, fault current is hundred of amperes.

In most cases, in order to examine the low grounding current, zero-sequence current transformer is often needed to obtain zero-sequence current.

This device is configured with two types of zero-sequence auxiliary TA, and according to practical condition, one type could be selected. The linear range of first type zero-sequence TA is  $(20mA \sim 5.50A)$ , input through terminal2 X2:13~2X2:14. If this zero-sequence TA is applied to obtain zero-sequence current, the control  
Contact: [sales@bueno-electric.com](mailto:sales@bueno-electric.com) Fax: +86-25-51816989



<https://www.bueno-electric.com>

character should be set to be KG1.10=1, with setting value of “zero-sequence current 1” and “zero-sequence time 1”. Because this zero-sequence TA shares one input channel with phase B measurement, at this time, the device could not measure phase B current.

When zero-sequence current is larger than setting “zero-sequence current 1” and reaches setting time “zero-sequence time 1”, output trip would operate or alarm signal would be sent. The operation modes could be selected through control character.

When control character KG1.10=0, the zero-sequence current protection function would be shutdown, and the measuring function of phase B measurement current of this channel would be realized.

The linear range of second type zero-sequence TA is (0.10A~20.00A), input through terminal 2X:7~2X:8. The zero-sequence current protection setting of this channel is determined by “zero-sequence current 2” and “zero-sequence time 2”.

When input zero-sequence current is larger than setting “zero-sequence current 2” and reaches setting time of “zero-sequence time 2”, output trip would operate.

#### 4.6 Negative-sequence current element

Negative-sequence current protection is mainly directed at various ungrounded asymmetric fault. For instance, when motor certain phase is broken, the magnitude of negative-sequence component is different, due to load rate before fault. When load rate is large than 0.7, the sound phase could produce over current. Therefore, conversional protection would not effectively protect asymmetric fault. During motor normal operation, due to asymmetric power supply, some negative-sequence current would always exist, and this current would not exceed 30%Ie. Negative-sequence protection setting could avoid this negative-sequence current, and it is set to be 0.3Ie.

This protection would apply three-phase protection TA as tacitly applied. When using two-phase protection TA, the control character should be KG1.11=1, and at this time, the negative-current could be computed according to following formula:

$$\begin{aligned}
3 \dot{I}_2 &= \dot{I}_A + a^2 \dot{I}_B + a \dot{I}_C \\
&= \dot{I}_A + a^2 (-\dot{I}_A - \dot{I}_C) + a \dot{I}_C \\
&= (1-a^2) \dot{I}_A + (a-a^2) \dot{I}_C \\
\dot{I}_2 &= \frac{\sqrt{3}}{3} \dot{I}_A e^{j30^\circ} + \frac{\sqrt{3}}{3} \dot{I}_C e^{j90^\circ}
\end{aligned}$$

The negative-sequence current in overheat protection would be computed according to above formula.



The device configures two-zone two-time-limit negative-sequence over current protection. Through control character KG1.3, negative-sequence over current zone I could be switched from the definite-time limit mode to the inverse-time limit mode.

At this time, the definite-time-limit function of negative-sequence over current zone II protection would not be affected.

#### 4.7 Inverse-time limit element

The inter-phase current and negative-sequence current of this device both have the protection function of definite-time limit and inverse-time limit, which could be selected through control character KG1.2 and KG1.3. Inverse-time limit protection is composed of extreme inverse-time limit characteristics in IEC standard, and its operation equation is:

$$t = \frac{80t_p}{\left(\frac{I}{I_p}\right)^2 - 1}$$

Where,

$t_p$  is time coefficient, with range of (0.05~1)

$I_p$  is current setting

$I$  is fault current

$t$  is tripping time

Notice: inverse-time limit time is the product of numerator (80 $t_p$ ) in above expression, with unit of second, and the setting range is 0.4s~80.0s.

#### 4.8 Overload protection

Overload protection could reflect the amount of motor stator current, and control character KG1.5 could be used to select alarm or trip. When current is larger than setting current and reached setting time, overload protection output would operate or alarm signal would be sent.

#### 4.9 Long-time startup protection

Long-time startup protection function could be operated or exited with control character KG1.6. When motor starts, this protection begins to operate. During startup process, when any phase current is larger than setting current and reaches setting time, long-time startup protection would carry out output operation. When motor startup finishes, the protection exits.

This protection shares the same operation indicating light with instantaneous protection. When the light is lit, the user would know what kind of protection is operating based on the message on LCD.



#### 4.10 Rotor-locked protection

Control character KG2.8 could be used to select the operation or shutdown of this function. When the switching that reflects motor rotation speed is in close state, and any phase current is larger than setting current and reaches setting time, the rotor-locked protection output would operate. This protection shares the same operation signal indicator light with instantaneous protection. When indicating light is lit, the user could distinguish the type of protection through the message displayed on LCD.

This protection must introduce motor rotation speed switching, with terminal of 4X:4 (KG2.4=0) .

#### 4.11 Fuse protection

For output motor circuit employing fuse plus contactor (FC) as the output, the device provides fuse protection. Control character KG2.5 could be used to select the operation or shutdown of this function. When contactor is closed, any phase current is larger than setting current, and suddenly changes to be zero; this state would delay after setting time. According to selection of control character KG2.7, fuse protection output would operate or alarm signal would be sent.

#### 4.12 F-C blocking function

When motor is controlled by fuse-contactor (F-C), high setting over current protection should be blocked, and fuse should be used to protect short circuit fault.

After startup (KG2.9=1) of this function, the instantaneous protection and zero-sequence over current protection operation would be blocked. It is recommended that when fuse-contactor (F-C) control is applied, the operation timeout of high setting protection should be added as much as possible, to ensure firstly reserved fuse is used to cut fault current, without blocking high settings protection operation.

#### 4.13 Under voltage protection

When voltage vanishes or descends, the motor rotation speed would drop. When voltage recovers, inside motor winding, the self-startup current begins, which is several times larger than rated current. Such large self-startup current would increase potential fall on power grid, and would prolong the voltage recovery process, and it would be more difficult for motor to reach normal rotation speed. In serious condition, the motor even could not carry out self-startup. To ensure the self-startup of important motor, when power supply vanishes or descends, according to requirements of production process and technical security, unallowed self-startup or self-startup is not necessary, and this part of motor should be cut through under voltage protection.

Therefore, motor load would be divided into two types here to distinguish, and on the basis of satisfying under-voltage, the two types are treated differently based on current magnitude. The conditions of operation are introduced as follows:

- 1) All the voltages are dropping, and lower than under-voltage setting



<https://www.bueno-electric.com>

- 2) Breaker or contactor is in close state
- 3) Under-voltage protection soft jumper is operating
- 4) Under-voltage protection is controlled through hard jumper (KG1.9=1), under the state of operation
- 5) Under-voltage protection operation time-delay is up.

Terminal of under-voltage protection hard functional switch is 4X:3, convenient for operators to operate or exit under-voltage protection function.

#### 4.14 Over-voltage protection

The breaker or contactor is in close state. When any line voltage is larger than over-voltage setting and reaches setting time, over-voltage output would operate, or alarm signal would be sent. The operation mode could be selected through control character KG1.13.

#### 4.15 Zero-sequence voltage protection

This protection function responds to the zero-sequence voltage caused by the motor stator grounding. When breaker is in close state, when zero-sequence voltage is larger than protection setting and reaches setting time, zero-sequence voltage output would operate, or alarm signal would be sent. The operation mode could be selected through control character KG1.14. Zero-sequence voltage is connected with AC input terminal 1X:5~1X:6.

#### 4.16 Non-electric quantity protection

This protection function must cooperate with exterior light control relay. The non-electric quantity contacts from motor are converted to be 24V through light control relay, and then switching terminals of input signal to device are 4X:1~4X:3. After receiving non-electric quantity signal BEPR- 822U could carry out output trip through time delay (at most 6000 seconds), send the signal, record the event, and upload the report to monitoring system computer through communication. For BEPR- 822U device, it could be controlled with control character KG1.7~KG1.9.

The default definitions of switching input terminals 4X:1 ~ 4X:3 and corresponding signal lights are introduced in the following table. If there is difference in project application, the situation could be determined by specific terminal of each project. When input 4X:3 serves as non-electric quantity input terminal, please ensure that KG1.9=0. It is specially indicated that as the related control character is placed at 1, the input terminals 4X1~4X:2 could be used as ordinary input terminals.

	BEPR- 822U	
	Default definition	Corresponding indicating lights
Non-electric quantity 1	Low water pressure	Non-electric quantity
Non-electric quantity 2	Low oil pressure	Non-electric quantity



Non-electric quantity 3	Under voltage	Non-electric quantity
-------------------------	---------------	-----------------------

#### 4.17 TV wire break detection

When one of the following three conditions is met, the device would send alarm signal and turn on the alarm light.

1) As one line voltage is lower than 70V, and certain phase current is larger than 0.25A, the case can be used to detect three-phase voltage loss and asymmetric wire breaks.

2) Negative-sequence phase voltage is larger than 8V, it can be used to detect TV asymmetric wire break. TV wire break detection function could be operated or exited with control character KG2.1.

#### 4.18 Measurement function

##### 4.18.1 Calibration of measurement channel

1) Insert the energy measurement sub-board into CUP board, pay attention that the direction could not be reversed. J1, J2 are respectively corresponding with J4, J5. Under normal operation, when measuring chip external 2.5V voltage reference, insert the three linking pieces of sub-board JP1 to near ON side.

When measuring self voltage reference, insert the three linking pieces of sub-board JP1 to far away from ON side.

2) External AC terminal connection: current, series connected, voltage, connected symmetrically, symmetric switch-on.

3) Offset check: No AC variables are added for external AC terminal. Enter “offset check” under the menu \System Configuration\ Energy Measuring Configuration, in about ten seconds, under \Sampling\Measurement Value, related current and voltage should all be 0 or near 0.

4) Gain check: Connect with current of 5A, line voltage of 100V. Under \System Configuration\ Energy Examination Configuration menu, enter “Gain check”, in about ten seconds, under \Sampling\Measurement Value, related current should be 5.000A, and related line voltage is 100V (error is within the scope of 0.2%.)

5) Under \System Configuration\ Energy Examination Configuration, first operate “Save configuration”, and then operate “Energy clearance”.

6) Interrupt the device power, and then energize it again. Connect with current and line voltage. Under \Sampling\Measurement Value, check the quantity of related current and voltage, confirm that the energy measurement configuration is saved.

##### 4.18.2 Display specification

1) “Measure Ia”, “Measure Ic” display the rms of the measuring current transformer phase A and phase C current. If there is no phase B measurement, 0 is displayed “Measure Ib”.

2) Measurement Uab, Ubc, Uca have the same input terminal as protection voltage Uab, Ubc, Uca. However the data are directly taken from special measurement module. “cosΦ” is power factor

3) Active power P is directly taken from special measurement module.

#### 4.18.3 Power measurement

This device applies two-meter-method to measure power. The direction of reactive power Q is decided by corresponding angle of protection line voltage and current.

Therefore, when examining reactive power, phase A and phase C protection current must be connected simultaneously.

### 5 Settings and Setting Specifications

#### 5.1 Setting value list and specifications of BEPR- 822U Digital Asynchronous Motor Protection

Setting value list of BEPR- 822U Digital Motor Comprehensive Protection

Ser.No	Setting name	Range	Unit	Remarks
1	Control character 1	0000~FFFF	No	Refer to definition of control character 1(KG1)
2	Control character 2	0000~FFFF	No	Refer to definition of control character 2(KG2)
3	Motor rated current	0.2~20.0	A	I <sub>e</sub>
4	Motor startup time	0.0~60	s	T <sub>start0</sub>
5	Instantaneous current setting	0.2~100.0	A	
6	Instantaneous time	0.0~20.00	s	
7	Over-current settings	0.2~100.0	A	
8	Over-current time	0.1~3000	s	
9	Over-current inverse-time limit time	0.1~3000	s	
10	Zero-sequence 1 current	0.02~5.50	A	
11	Zero-sequence current 1 time	0.0~20.00	s	
12	Zero-sequence 2 current	0.1~20.00	A	
13	Zero-sequence current 2 time	0.0~20.00	s	
14	Negative-sequence zone I	0.1~100.0	A	



Ser.No	Setting name	Range	Unit	Remarks
	current			
15	Negative-sequence zone I time	0.04~20.00	s	
16	Negative-sequence inverse-time limit time	0.005~127.0	s	Extreme inverse-time limit, with exponent of 2
17	Negative-sequence zone II current	0.1~100.0	A	
18	Negative-sequence zone II time	0.04~20.00	s	
19	Overheat startup current	0.2~100.0	A	$I_o$
20	heating time constant $\tau$	6.0~3000	s	$\tau$
21	Negative-sequence current thermal effect coefficient	3~10		Usually 6 is taken
22	Overheat alarm coefficient	0.3~1.0		Usually 80% is taken
23	Multiples of dissipation time	0.1~5.0		Usually 4.0 is taken
24	Low voltage settings	0.0~120.0	V	
25	Low voltage operation time	0.0~100.0	s	
26	Over load current	0.2~100.0	A	
27	Warning over load time	0.1~3000	s	
28	The tripping over load time	0.1~3000	s	
29	Over-voltage settings	0.0~120.0	V	
30	Over-voltage operation time	0.0~100.0	s	
31	Zero-sequence voltage settings	0.0~120.0	V	
32	Zero-sequence voltage time	0.0~100.0	s	
33	Rotor-locked current settings	0.2~100.0	A	
34	Rotor-locked time settings	0.1~100.0	s	



Ser.No	Setting name	Range	Unit	Remarks
35	Long startup current settings	0.2~100.0	A	
36	Permit start time	0.1~100.0	s	
37	F-C blocking current	0.2~100.0	A	
38	F—C Tripped over time	0.04~20.00	s	
39	Non-electric quantity 1 time delay	0~6000	s	
40	Non-electric quantity 2 time delay	0~6000	s	
41	Non-electric quantity 3 time delay	0~6000	s	
42	Measure TA ratio (kA/A)	0.01~10		primary measureTA ratio/1000
43	TV ratio (kV/V)	0.01~10		primary TV ratio/1000 Control character 1 (KG1) definitions of BEPR- 822U Digital Motor Comprehensive

Control character 1 (KG1) definitions of BEPR- 822U Digital Motor Comprehensive Protection

Bit	Meanings for 1	Meanings for 0
15	TA rated current is <b>1A</b> .	TA rated current is <b>5A</b> .
14	Zero-sequence over-voltage <b>trip</b>	Zero-sequence over-voltage <b>alarm</b>
13	Over-voltage <b>trip</b>	Over-voltage <b>alarm</b>
12	Control back to break the discriminant investment	Control back to break the discriminant exit
11	Three phase protection TA	Two phase protection TA
10	2X : 13&14 switch on 3I0	2X : 13&14 switch on Ibc
9	4 X: 3 control voltage protection	4 X: 3 for Non-electric input
8	Non-electric quantity 2 <b>exits</b>	Non-electric quantity 2 <b>operates</b>
7	Non-electric quantity 1 <b>exits</b>	Non-electric quantity 1 <b>operates</b>
6	Long startup protection <b>operates</b>	Long startup protection <b>exits</b>
5	Overload <b>trip</b>	Overload <b>alarm</b>

4	Zero-sequence over-current <b>trip</b>	Zero-sequence over-current <b>alarm</b>
3	Negative-sequence zone I selects <b>inverse-time limit mode</b>	Negative-sequence zone I selects <b>definite-time limit mode</b>
2	Over-current selects inverse-time limit mode	Over-current selects definite-time limit mode
1	Overheat blocking <b>operates</b>	Overheat blocking <b>exits</b>
0	Overheat alarm <b>operates</b>	Overheat alarm <b>exits</b>

Control character 2 (KG2) definition of BEPR- 822U Digital Motor Comprehensive Protection

Bit	Meanings for 1	Meanings for 0
15	Motor startup discrimination exits	Motor startup discrimination operates.
14~13	Standby	Standby
12	Measuring CT: Three-phase	Measuring CT: Two-phase
11	External thermal return - operates	External thermal return - exits
10	3U0 external PT	3U0 from itself
9	FC large current blocking operates	FC large current blocking exits.
8	Rotor-locked protection operates	Rotor-locked protection exits.
7	Fuse protection trip	Fuse protection alarm
6	X5 : 1&2 are used as pulses	X5 : 1&2 are used as telesignal variables
5	Fuse protection operates	Fuse protection exits
4	4X:4 external thermal reset operates	4X : 4 external thermal reset exits
3	4X : 8 external reset <b>operates</b>	4X : 8 external reset <b>exits</b>
2	Standby	Standby
1	TV wire break discrimination <b>operates</b>	TV wire break discrimination <b>exits</b> .
0	Standby	Standby

Specifications:

1) DI terminals in BEPR- 822U 4X:1, 4X:2, 4X:4 and 4X:8 , when their corresponding functions set in KG1, KG2 exit, could be used as ordinary switching input terminals.

2) The non-electric quantity protections in BEPR- 822U are defined as follows.

According to different project terminals, related changes must be made.

	Default definition	Corresponding indicating light
Non-electric quantity 1	Low water pressure	Non-electric quantity
Non-electric quantity 2	Low oil pressure	Non-electric quantity
Non-electric quantity 3	Under voltage	Non-electric quantity

## 5.2 Soft pressure plates and specification of BEPR- 822U Series Digital Asynchronous Motor Protection

Soft pressure plates and specification of BEPR- 822U Digital Motor Comprehensive Protection

Jumper name	Corresponding function
Instantaneous	Operation and exit of current instantaneous function
Over-current	Operation and exit of overcurrent protection function
Zero-sequence current	Operation and exit of zero-sequence overcurrent protection function
Negative-sequence current	Operation and exit of negative sequence overcurrent protection function
Overheat	Operation and exit of overheat protection function
Overload	Operation and exit of overload protection function
Under-voltage	Operation and exit of under-voltage protection function
Over voltage	Operation and exit of over voltage protection function
Zero-sequence voltage	Operation and exit of zero-sequence voltage protection function
Non-electric quantity	Motor startup process monitoring

Specifications: the protection function could be operated or exited with soft jumper, and be realized under the menu of “*system configuration/jumper configuration*”.

Please refer to *Operation Manual of BEPR- 822U Digital Asynchronous Motor Protection*, for more details.



**Part 2**

# **Operation Manual**



## 1 Introduction

### 1.1 Keyboard

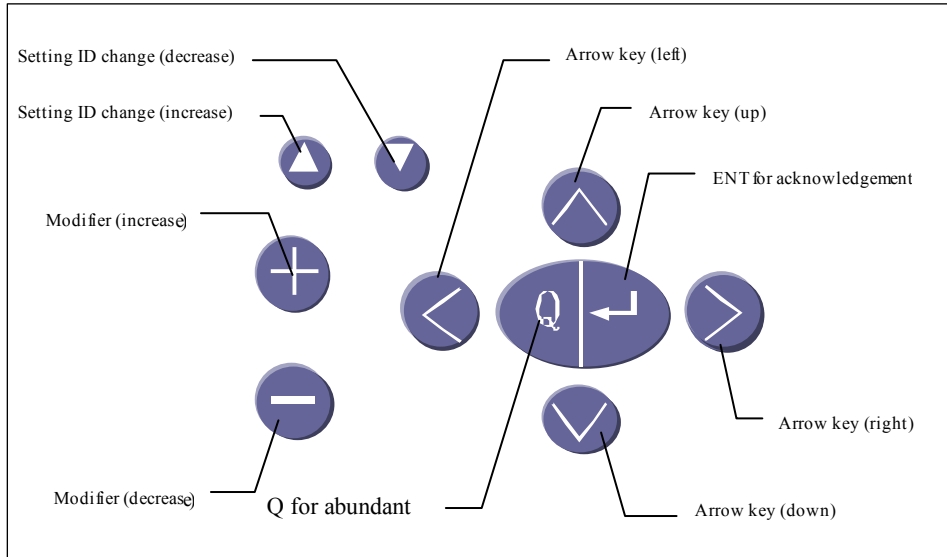

**Schematic Diagram for the keyboard of the BEPR- 800 Series Protection**

## 2 Menu operation

The keyboard for the BEPR- 800 Series Digital Protection and LCD interface are operated in the way of the interaction block in combination with the menus.

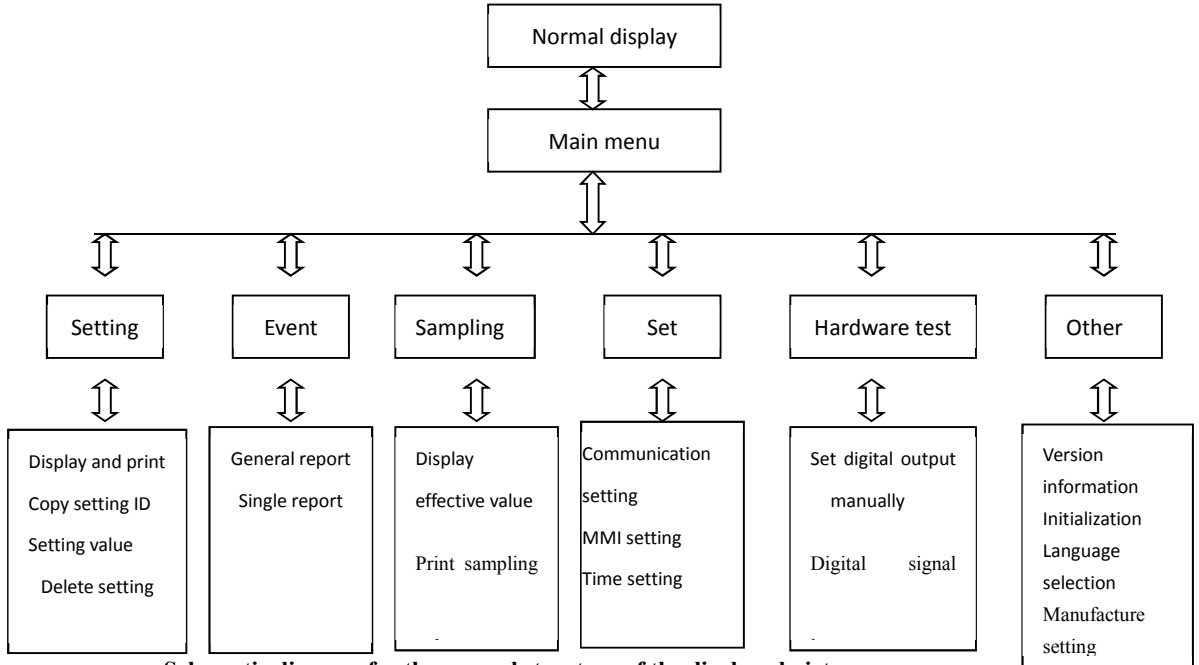

Schematic diagram for the general structure of the displayed picture

### 2.1 Functions

#### 2.1.1 Sampling

RMS value : shows in real-time the RMS values and phase angles for all the analog channels;

Measured value : shows in real-time the magnitudes of the measured-variables;

Electric quantity value : shows in real-time KWHs.

#### 2.1.2 Event

Display, check or printing of the fault reports.

#### 2.1.3 Rated value

Rated value display : shows the rated values in all the setting zones ;

Rated value switching : switch from one setting zone to another one ;

Rated value amendment : amend the rated values in the selected setting zone ;

Rated value printing : print the rated value list for the selected setting zone.

#### 2.1.4 System setup

Pressure plate setup :in-service and out-of-service of the functional soft pressure plates ;

Time adjustment : adjust the time of the protection ;

Energy –measuring setup :

✓ Offset check : check the zero-shift ;

✓ Gain check : check its linearity;

- ✓ Save setup : save corrected settings ;
- ✓ Energy-clearance : KWH clearance :

### 2.1.5 System test

Switch-out drive : manual control output or return of the output switching variables ;

Switch-in check : real-time display of the switch-in variables ;

AC test : real-time display of values and phase angles for all the analog channels ;

Integrated automation function : integrated use of the information from the background monitoring and telecontrol station .

- ✓ Protection upstream transmission : transmit protection SOE reports one by one;
- ✓ Alarm upstream transmission : transmit alarm reports one by one ;
- ✓ Telesignal upstream transmission : transmit the telesignalling position-varying information one by one ;
- ✓ Telemeter upstream transmission : transmit the telemetering variables one by one . the fixed quantity for transmission is the half of the full scaled value ;
- ✓ Code list printing : print all the internal communication code lists, including protection SOE list, alarm information list, soft pressure plate formation list, telesignaling list, telemetering list, telecontrol list.

### 2.1.6 Others

Display the program version information, logic information and identifications.

### 2.1.7 Operation set up

Setup of the protection soft pressure plates, setting zone switching rated value amendment and time adjustment

## 2.2 Operation instructions

### 2.2.1 Normal display

When the protection is energized and the mode switch is pointed at “Local” or “Remote”, the MMI turns to normal display :

BEPR- 800 Digital Protection	
Setting zone	01
2000-02-18 09:09:30	

BEPR-800 Digital Protection	
Setting zone	01
Ia	0.013A -153.7°
Ib	0.010A -164.5°
Ic	0.014A -168.6°



In normal operation, the display will alternatively shows the number of the current setting zone, date and time information, RMS values of current, voltage and phase angle etc.

### 2.2.2 Primary menu

When **【←↓】** key is pressed, the primary menu will show :

Primary menu	
Sampling	System setup
Event	Hardware test
Setting	Others

Then press “^” or “~”, “<” or “>” keys to select menu and press **【←↓】** key to select the sub menu. press **【Q】** to return to previous display.

### 2.2.3 Sampling

#### 2.2.3.1 RMS

After entering this menu, MMI will renew RMS values and phase angles of all the analog channels every 3 seconds.

RMS		
Ia	0.013 A	-153.7°
Ib	0.010 A	-164.5°
Ic	0.014 A	-168.6°

Press “^” or “~” key to turn the lines and press “+” or “-” key to turn pages.

#### 2.2.3.2 Measured value

After entering this menu, MMI will renew measured values every 3 seconds.

Measured value		
Measure	Ia	0.013A
Measure	Ib	0.010A
Measure	Ic	0.014A

Press “^” or “~” key to turn the lines. Press “+” or “-” key to turn pages.

#### 2.2.3.3 Electric quantity

After entering this menu, the menu MMI will renew the KWHs every 3 seconds.

	KWH
Pulse P	0
Pulse Q	0
+ KWh	0.0 KWh

Press “^” or “v” key to turn lines. Press “+” or “-” key to turn the pages.

### 2.2.4 Event

#### 2.2.4.1 Report display

In case of no fault report, MMI will display a news block indicating that there is no fault report. It resumes automatically after 2 seconds if key Q is not pressed under the news block.

Report display
No event report

In case there are events reports in the system, a browsing window for fault report will be display. Press “+” or “-” key to search the previous one or the next one, press “^” or “v” key to look for a previous record or next one.

03	2000-02-18	10:30:00:000
0 ms protection start		
20ms overcurrent relay zone I operation		
2059ms reclosing operation		

#### Form at for report display

This time press 【←↵】 key asking if the fault report should be printed

Report printing
Will the report be printed?

Within 3 seconds, press 【←↵】 key to print this report, otherwise the display will exit. If the printing is finished, it will show

Report printing
Printing is finished

If the printer or communication are in failure, then the display shows

Report printing  
Printing server is busy

#### 2.2.4.2 Recording printing

In case there is a recording report in the system, a browsing window for the recorded report will show, press “+” or “-” key to search the report. Press 【←↓】 key to print

Recording selection  
Number 00±  
Zone quantity 1  
00. 12.08 15:28:14. 003

#### Recording report select

#### 2.2.5 Setting

##### 2.2.5.1 Setting display

After entering the menu, MMI begins to indicate which setting zone you want to select. Press “+” or “-” key to select zone number. Press 【←↓】 key to perform the setting display.

Setting display  
Select setting zone : 00±  
current operating zone : 01

#### Setting zone selection

Setting display (0)  
Control character I.....0000  
Control character II.... 0000  
Current zone I.....100.0A

#### Setting display

**Note : The system defaulted setting will be displayed for the invalid setting zones.**

Press “^” or “v” key for turn the lines. Press “+” or “-” key to turn the pages.

##### 2.2.5.2 Setting alteration

Select the submenu “setting alteration” under menu “system setup”. The system will indicate which area you want to alter setting zone :

```

Setting alteration
Select setting zone : 00±

Current operating zone : 01

```

After the setting zone is selected, press **【←↓】** key to enter the setting alteration window :

```

Setting alteration (0)
Control character 1....0000
Control character 2...100.0A
Current zone 1.....100.0A

```

**Note : The system defaulted setting will be displayed for the invalid setting zones.**

After entering the setting alteration window, press “^” or “v” key, “<” or “>” key to select the alteration position press “+” or “-” key to make alteration For the contents in the effective bit of the control Character press “>” key and hold it for 3 second, the selective sub-menu containing the contents in the effective bit of the control character are displayed. In the sub-menu, the effective bit of the control character can be easily put in-service or out of service.

```

Control character .....0000
Analog variable summation self-check
withdrawal ±
TA rated current 5A
CB stealing tripping and reclosing

```

After alteration, press**【←↓】**key to confirm. In case of giving up the alteration, press “Q” key. The system will give up the alteration and return to the previous menu.

After all the alteration are confirmed to be completed, press**【←↓】** key to solidify. In case of giving up the alteration, press “Q” key, the system will give up the alteration and return to the previous menu.

Before solidification, the system wants you to identify the target for solidification. By doing so, the alteration zone and duplication of a setting zone can be completed.

```

Setting solidification
Select setting zone : 00±

Current operating zone : 01

```

When the target solidification zone is selected, press **【←↓】** key to solidify. The system asks you entering the secret codes, the process will not be repeated here.

### 2.2.5.3 Setting switchover

Select the submenu “setting switchover” under the menu “operation setup” or press the “setting switchover” key, a setting change window will be seen directly.

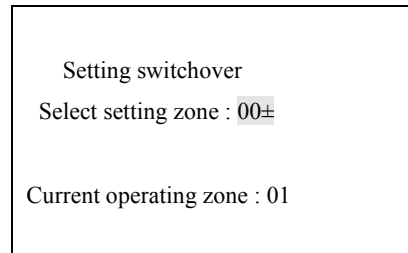

Use “+” or “-” key to select setting area you want to change (also it can be done by the setting switchover keys). If you want to give up the switchover, just press “Q” key. press 【←↓】 key to start the switchover. The system asks you entering the secret code. The process is the same as the pressure plate switchover and will not be repeated here.

Several setting zone are provided for storage. Before operating a setting switchover, care must be taken that the zone you want to switch over must have its settings otherwise you cannot make any switch. By using the command “setting alteration” you can write several sets of setting into the zone and then make switchover..

### 2.2.5.4 Setting printing

In the setting print menu, MMI will first ask you to select setting zone. Press “+” and “-” keys to select the number of the setting zone to be printed. Press 【←↓】 key to make the setting printing.

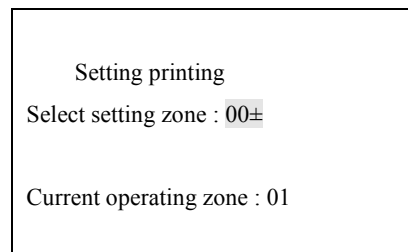

#### Setting zone selection

Use “^” or “v” key to turn the lines, “+” or “-” key to turn the pages .

### 2.2.6 System setup

#### 2.2.6.1 Pressure plate setup

Select submenu “pressure plate setup” under menu “system setup”, the window will show :

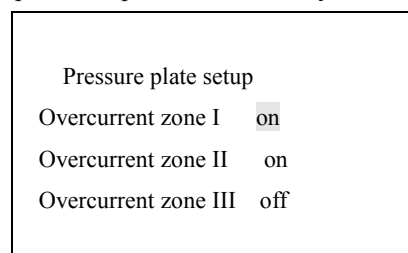

Use “^” or “v” key to select the different plates, use “+” or “-” key to select in-service or out of service. If the setup is required to given up. Press “Q” key. Press 【←↵】 key starts to setup pressure plate. System asks for the secret codes.

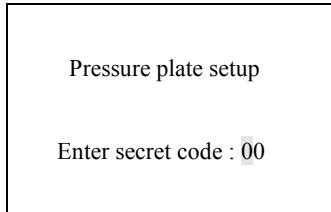

In case secret codes are in error, an news window for error will be seen. Otherwise, the news window for the result of the pressure plate setup will be seen.

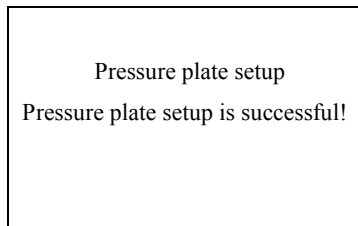
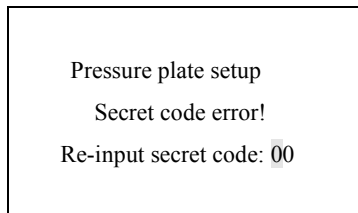

In any case, when “Q” key is pressed, display will go back to the previous menu.

#### 2.2.6.2 Time adjustment

Select the “time adjustment”, use “^” or “v” key to turn the lines “+” or “-” key to switch for the in service or out of service of the function.

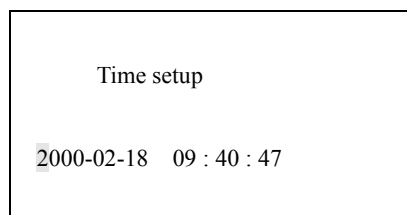

#### 2.2.6.3 Energy-measuring setup

Select the menu “energy-measuring setup”, use “^” or “v” key to select .

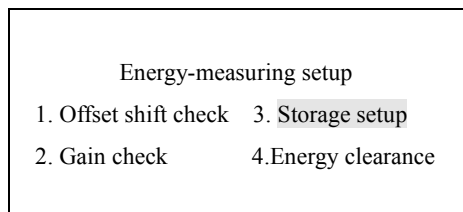

##### 2.2.6.3.1 Offset shift check

Select the menu “shift check” enter security secret codes, a waiting notice is shown:

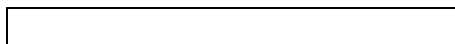

Offset shift check  
Offset shift check is going on !  
Wait a moment...

After finishing check it returns to “energy-measuring setup

Offset shift check  
Offset shift check is finished

#### 2.2.6.3.2 Gain check setup

select the “ gain check” menu, after entering the secret codes, a waiting notice is shown .

Gain check  
Gain check is going on !  
Wait a moment

After finishing the check a display for the completion is seen and it returns to the menu “energy-measuring setup”

Gain check  
Gain check finished  
Check results

#### 2.2.6.3.3 Energy-measuring setup

Select the menu “save setup”, enter the secret codes and finish the zero clearance

#### 2.2.6.3.4 Energy zero clearance

Select the menu “energy zero clearance”, enter the secret codes and finish zero clearance.

#### 2.2.7 System test

A set of the interaction block is provided in the BEPR- 800 Series Digital Protection. By operating this set of the interaction block. Users can perform the tests on the switch out (relay) drive, switch-in real-time display (manual detection of the switch-in signals), real-time display of the analog variables in the AC input channels and the related functions for the integrated automation. Since this set of operations is generally used to test the perfect state of the definitions for the protection, monitoring and telecontrol back ground data bases, it is called the “system test”

operations. For the “switch-out drive”, “AC test” operations, the position of the switch must be put at “local” position, and for the integrated automation “function” at the “remote” position. But for the “switch-in check” operation, both the “local” and “remote” modes will do.

### 2.2.7.1 Switch-out drive

Select the sub menu “Switch-out drive” under the menu “System test”, the system asks for the secret code :

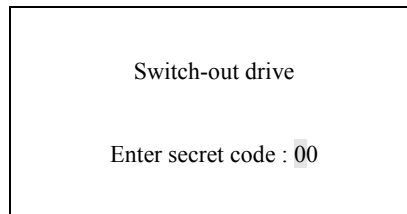

Use “<” or “>” key to select the enter position, use “+” or “-” key to enter the secret codes. Press 【←↵】 key to enter. In case the secret codes are in error, a news block indicating the error secret codes can be seen :

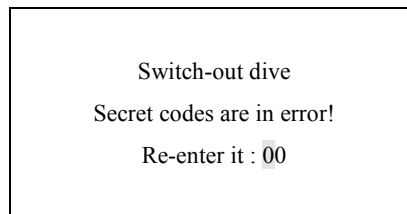

When the correct secret codes are entered, the system indicates that the menu “switch-out drive” has been entered :

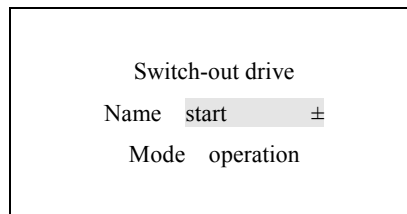

Use “^” or “v” key to select the different input items, use “+” or “-” key to select name and mode of the switch-out, Press 【←↵】 key to start operation.

### 2.2.7.2 Switch-in check

Select the sub-menu “switch-in check” under the menu “system test”. The system will enter directly the menu “switch-in check”. The MMI will renew the switch-in status every 2 seconds.

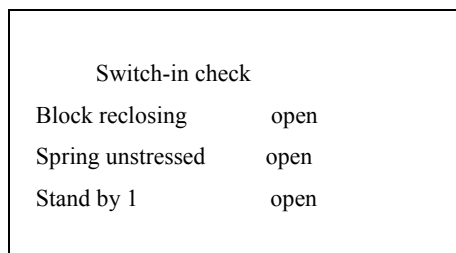

Use “^” or “v” key to turn the lines and, use “+” or “-” key to turn the pages .

### 2.2.7.3 AC test



**During AC test, protection is put out of service, so as to do the channel precision tests in heavy current.**

Select the sub-menu “AC test” under the menu “system test”, systems asks for the secret cods.

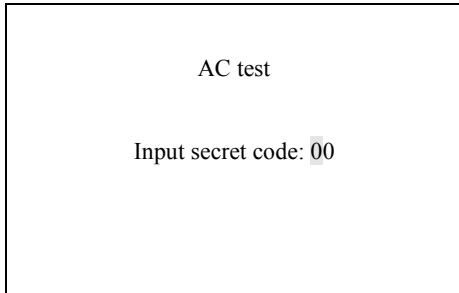

**Secret codes check window**

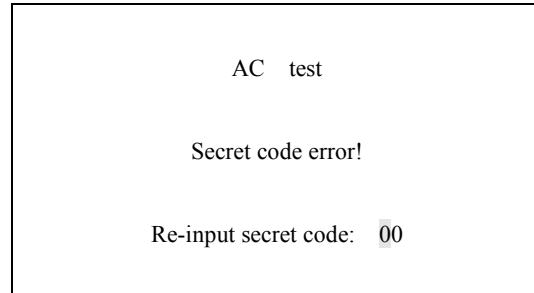

**News block for the error secret codes**

When the secret codes are correctly entered, the system indicates that the menu “AC test” has been entered. The MMI renews the channel RMS values and phase angles every 3 seconds .

AC test		
Ia	0.013 A	-153.7°
Ib	0.010 A	-164.5°
Ic	0.014 A	-168.6°

Use “^” or “v” key to turn the lines “+” or “-” key to turn the pages.

**2.2.7.4 Integrated automation function**

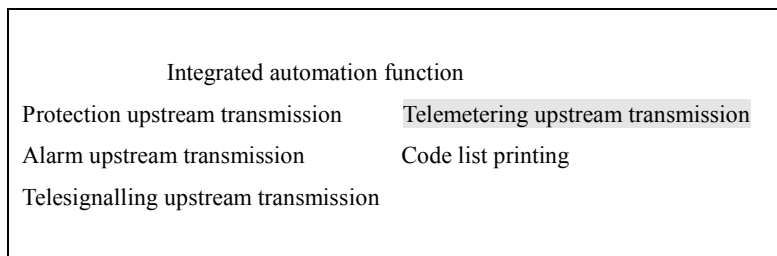

**2.2.7.4.1 Protection upstream transmission**

Enter “protection upstream transmission” and enter the secret codes, a picture is shown.

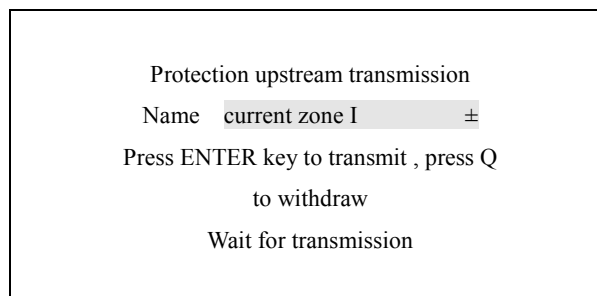

Press 【←↵】 key, the operating information of protection zone I is sent to the monitoring and telecontrol background

Protection upstream transmission  
Name **current zone I** ±  
Press ENTER key to transmit, press Q  
to withdraw  
The data for the first time has been sent  
out go on please!

Use “+” or “-” key to switch over onto the different entities, press ENTER to transmit the information of the related entities..

Press “Q” to exit from the “protection upstream transmission” and return to the menu integrated automation

#### 2.2.7.4.2 Alarm upstream transmission

After entering the “ Alarm upstream transmission”, enter secret coded, a picture is shown :

Alarm upstream transmission  
Name **energization** ±  
Press ENTER to transmit press Q to  
withdraw  
Wait for transmission

Press **【←↵】** key, the alarm information of energization will be transmitted to the monitoring and telecontrol background

Alarm upstream transmission  
Name **energization** ±  
Press ENTER to transmit press Q to  
withdraw  
The data for the first time has been  
transmitted, go on please !

Use “+” or “-” key to switch over on to different entities, press ENTER to send corresponding information.

Press “Q” to exit from the “alarm upstream transmission” and return to the menu “Integrated automation”

#### 2.2.7.4.3 Telesignalling upstream transmission

After entering the “telesignalling upstream transmission” enter the secret code.

```
Tele-signaling upstream transmission
Name  standby 1 ±
Press ENTER to transmit, press “Q” to
withdraw
Wait for transmission
```

Press **【←↵】** key and send stand-by 1 tele-signaling displacement information to the monitoring and telecontrol background

```
Telesignalling upstream transmission
Name  standby 1 ±
Press ENTER to transmit, press “Q” to
withdraw
The data for the first time has been
transmitted, go on please !
```

Use “+” or “-” key to switch over on to different entities, press ENTER to send the corresponding information.

Press “Q” to exit from the “telesignalling upstream transmission” and return to menu “Integrated automation”

#### 2.2.7.4.4 Telemetry upstream transmission

After entering the “telemetry upstream transmission”, enter secret codes a picture is shown :

```
Telemetry upstream transmission
Name  measure Ia ±
Press ENTER to transmit, press “Q” to
withdraw
Wait for transmission
```

Press **【←↵】** key to send the Ia information to the monitoring and telecontrol background. The transmitted value is the half of full scaled value.

```
Telemetry upstream transmission
Name  measure Ia ±
Press ENTER to transmit, press “Q” to
withdraw
The data for the first time has been
```

transmitted, go on please

Use “+” or “-” key to switchover onto the different entities, press ENTER to transmit the related information.

Press “Q” to exit from this function and return to “Integrated automation”

#### 2.2.7.4.5 Code list printing

Entering the “code list printing”, a picture is shown:

```
Code list printing

Printing code list ?
```

Press [←] key to print, press “Q” to exit from this function

#### 2.2.8 Others

A set of the operating menus (interaction block) is provided in the BEPR- 800 Digital Protection including the version information, logic information, IP address setup, etc..

##### 2.2.8.1 Version information

```
Version information

Name :   BEPR-811 Line Protection
Edition : V 1.03A
CRC0 :  37F8      CRC1 :  37F8
```

##### 2.2.8.2 Logic information

```
Logic information

Type :      Line Protection
Serial no : T641 V1.40S005-
CRC code :  4FFE
```

##### 2.2.8.3 Identification

Select the sub-menu “identification” under the menu “Others”

```
Identification

IP add :  172. 020. 010. 001
Name :    LV Protection
```

IP address is composed with four bytes divided by dots. Each byte is the decimal integral number from 0 to 255. It is used for identification in network communication within sub-stations.

The same IP address is not allowed in one sub-station. The first and second bytes were decided by Contact: [sales@bueno-electric.com](mailto:sales@bueno-electric.com)

Fax: +86-25-51816989

the network. The third and fourth (00.XX), (01. XX), 255.XX), (XX. 00), (XX. 255) are to be saved and can not be used.

As the protection is connected into the signal network configured system, the network no. of the IP address is recognized as “172.20”. As protection is connected into the dual-network configured system, for the network no. of the IP address, refer to the description about the “network interface module COMM” in the “Manual for the BEPR- 861 Integrated Monitoring Device”. It is dependent upon the setting of the module in the system.

Use “<” or “>” to select the position to enter. Use “+” or “-” key to enter the address. press 【←↓】 key to setup, then the system indicates that the secret codes can be entered, if it is correctly entered system will indicate that the address is correctly setup and exit from the submenu.

### 2.2.9 Operation setup

Under the normal operating conditions, as the mode switch on the panel is put at the “operation setup”, the system automatically enters the menu “operation setup” :

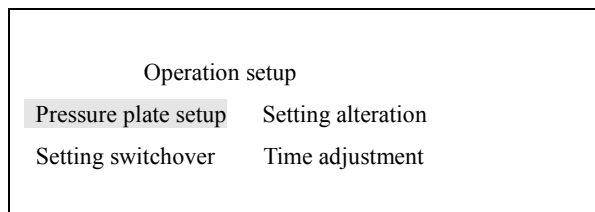

In this menu. Use “^” or “v” key and “<” or “>” key to select menu items, then press 【←↓】 key to enter the sub-menus or do the corresponding operations. Press “Q” to return to the previous picture.

#### 2.2.9.1 Pressure plate setup

Select the sub menu “Pressure plate setup” under the menu “operation setup” and enter pressure plate setup window :

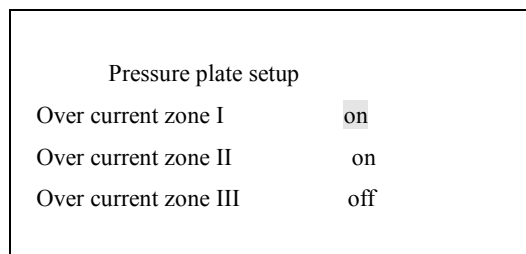

Use “^” or “v” key to select the different pressure plate, use “+” or “-” key to select on or off. Press “Q” to give up. Press 【←↓】 key to start setup. System asks for secret codes :

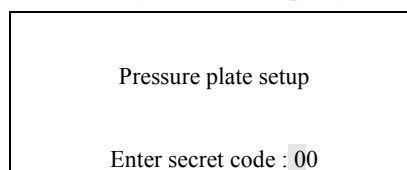

If the secret codes are in error, a news block for the error secret codes is displayed.

If the secret code' are correct, news block for the correct secret codes is displayed.

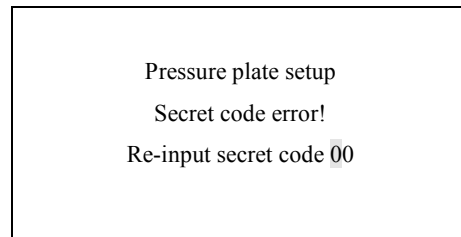
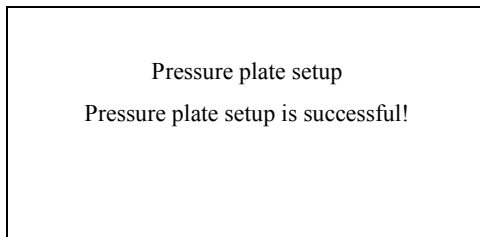

Under any conditions, when “Q” key is pressed, system will return back to the previous menu.

### 2.2.9.2 Setting switchover

Select sub-menu “setting switchover” under the menu “operation setup” or press the setting switchover key directly, a setting switchover window will be seen :

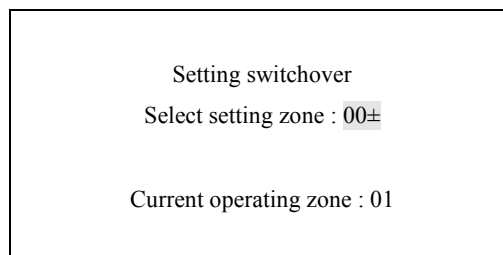

Use “+” or “—” key to select the setting zone you want to switchover (also it can be done by the setting switchover keys). If you want to give up the switchover, just press Q key. Press 【←↵】 key to start the switchover. The system asks you enter the secret codes. The process is the same as the pressure plate switchover and will not be repeated.

Several setting zone are provided for storage. Before operating a setting switchover, care must be taken that the zone you want to switchover must already have its settings, otherwise, you cannot make any change. By using command “setting switchover”, you can write several sets of settings in the zone and then make changes.

### 2.2.9.3 Setting alteration

Select the sub-menu “setting alteration” under the menu “operation setup”. The system will ask you which area you want to alter :

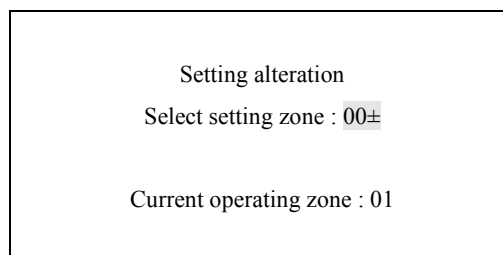

After the setting zone is selected . Press 【←↓】 key to get the setting alteration window :

```
Setting alteration (area 0)
Control character 1 .....0000
Control character 2 .....100.0A
Current zone I ..... 200.0A
```

**Note : The system defaulted setting will be displayed for the invalid setting zone.**

After entering setting alteration window, press“^” or “√” key and “<” or “>” key to select the position for alteration. Press “+” or “-” key to make alteration. For the contents in the effective bit of the control character, press “>” key and hold it for 3 seconds, the selective submenu containing the contents in the effective bit of the control character are displayed. In the submenu, effective bit or the control character can be easily put in-service or out of service. But the combined control bit must be entered through the manual calculation.

```
Control character
Current zone I without direction ±
Current zone II without direction
Current zone III without direction
```

After alteration, press【←↓】key to confirm. In case of giving up the alteration, press “Q” key. The system will return to the main menu.

After all the alterations are completed, press 【←↓】 key to solidify. In case of giving up the alteration, press “Q” key, the system will return to the previous menu.

Before solidification, the system wants you to identify the target zone to perform the alteration. By doing so, the alteration or duplication of a setting zone can be realized.

```
Setting solidification
Select setting zone : 00±

Current operating zone : 01
```

When the target solidification zone is selected, press 【←↓】 key to solidify. The system asks you enter the secret . The process is the same as the setting switchover and will not to be repeated here.

#### 2.2.9.4 Time adjustment

After entering the window, use “+” or “-” key to adjust the time to the precise time, press 【←】 key to start setup, when it is done, MMI returns to the previous menu automatically.

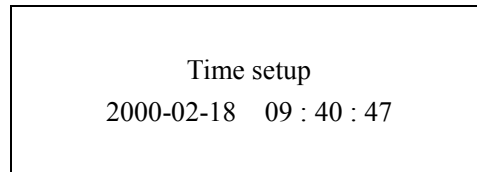

#### 2.2.10 Note

Reset key is pressed to reset all lamp signals and switching-outs.

Press “Q” key for more than 1 second, the display will directly return to the main picture.

### 3 Debugging Outlines for Users.

This protection and its panel-assembled cabinet have been strictly debugged in the factory and as they are delivered, they are in the perfect conditions and correctly connected. The user’s debugging on the protection is to check whether any damages have occurred in the transportation and installation and whether the outgoing connections are correct. Since the perfect self-detection functions of the software and hardware are provided in the protection, the failed parts can be precisely located at the modules or ever chips. No adjustable components are mounted in the AC sampling circuit, which is excellent in its vibration-proof capability and temperature property, so the precision of the protection can be ensured by the delivery test. The test emphasis can be thus placed on the parts of the status variable inputs(opto-coupler) ,

AC inputs, tripping and closing output circuits and signal circuits (relay contacts). Although the following debugging procedures are directed at the protection as whole the debugging operations had better to be made on the panels and cabinets, that is, the internal panel connections should be included in the detection.

#### 3.1 Check before energization

The advanced manufacturing technology is adopted and no adjustable components are used and. A large quantity of the LSI circuits is employed in the protection. For the sake of its reliability, in the normal test state, don’t pullout any, even in the insulation check.

Before energization check whether the surface is perfect without any damages and loosen parts for terminals and whether the parameters are consistent with the specifications. The special tests should be made on the power supply voltage. TA rated current, tripping rated current and closing rated current, etc.

#### 3.2 Insulation check

The modules and terminals are connected in parallel (insulation test may be done on the communication terminals). The insulation to the ground for modules is tested by the 500V megaohmmeter and the tested insulation resistance should be larger than 100 MΩ. As the filters



are located at the 24V, 200V output and input inlets of the power supply module and the capacitance to ground is present, the power supply socket can be pulled out in the insulation test.

### **3.3 Energization check**

- a. The groups at the settings are input into the related setting zones per the setting list and the setting zones are switched into the operating setting zones.
- b. The protection pressure plates are put in service and the lamp signals on the panel will indicate the in-service conditions of the protection.

### **3.4 Sampling precision check**

No adjustments are required for the sampling precision of the protection and the sampling error should not larger than 2%. Generally, the check can be specifically done by the microprocessor-based protection testing instrument. To meet the more strict requirements, the phase current input terminals of the protection can be connected in-series to the current of 5A, the TVs for the various phases are connected in parallel to the voltage of 50V. Now the accurate values are displayed and consistent for the various phases. In the meantime, the check should be done to see whether the phases for the analog channels are correct.

### **3.5 Contact output check**

The contact output check, including the signal contact output check, can be done in combination with the setting check. The contact output for each channel is once checked, in the other tests, only the signal indications and LCD display are required to be observed.

The contact output check can also be done via the menu “Switch-out drive” of the protection. The functions of this menu can be driven separately for each output. The operating methods can be seen in the “Operating Guidelines” of the Operation Manual.

The tripping drive and closing drive test with the circuit breakers should be done for onetime to confirm the correct operation of the circuit breakers.

### **3.6 Setting check**

The dynamic simulation tests or other tests on the protection functions and operational logic have been done for several times. The field debugging can only be done to check the settings.

### **3.7 Tripping and closing current hold test**

Put the tripping and closing pressure plates in service and simulate the faults to make the protection operate and confirm the perfect conditions of the tripping and closing currents. The manual tripping and closing operations can also be done to inspect the perfect state of the circuit. The protection should not be reclosed after the manual tripping of the circuit breakers.

### **3.8 Phase sequence check**

As the line is energized, observe whether the currents, voltages for phases and their phase angles are consistent with the actual conditions.

---

### **3.9 Calibration of the clock**

Check whether the clock is accurate in time. If it is not accurate, the calibration can be made. The operating methods are shown in the “Operating Guidelines”.

It is convinced from the above checks that the protection and panels as well as cabinets are correctly connected and they can function normally and can be put in operation.